

# Single relay - REL-IR/LDM- 24DC/4X21AU - 2834203

Please be informed that the data shown in this PDF Document is generated from our Online Catalog. Please find the complete data in the user's documentation. Our General Terms of Use for Downloads are valid (<http://phoenixcontact.com/download>)



Pluggable industrial relays with power contacts and additional hard gold plating, 4 PDT, test button, status LED, free-wheeling diode, mechanical switch position indicator, polarity A1-, A2+, coil voltage: 24 V DC

## Your advantages

- With detectable manual operation
- DC types with integrated freewheeling diode
- Mechanical switch position indicator
- Integrated status LED

## Key Commercial Data

Packing unit	10 pc
Minimum order quantity	10 pc
GTIN	 4 017918 941734
GTIN	4017918941734
Weight per Piece (excluding packing)	38.500 g
Weight per piece (including packing)	38.500 g
Custom tariff number	85364190
Country of origin	Japan
Note	Made to Order (non-returnable)

## Technical data

### Dimensions

Width	21.5 mm
Height	28 mm
Depth	36 mm

### Ambient conditions

Ambient temperature (operation)	-55 °C ... 70 °C
Ambient temperature (storage/transport)	-55 °C ... 70 °C

# Single relay - REL-IR/LDM- 24DC/4X21AU - 2834203

## Technical data

### Coil side

Nominal input voltage $U_N$	24 V DC
Typical input current at $U_N$	38 mA
Typical response time	13 ms
Typical release time	14 ms
Coil resistance	630 $\Omega$ $\pm$ 15 % (at 20 °C)
Power dissipation for nominal condition	0.91 W

### Contact side

Contact type	4 PDTs
Type of switch contact	Single contact
Contact material	AgNi, hard gold-plated
Maximum switching voltage	250 V AC/DC
Minimum switching voltage	1 V
Min. switching current	1 mA
Maximum inrush current	12 A (15 ms)
Limiting continuous current	5 A
Interrupting rating (ohmic load) max.	1250 VA (for 250 V AC)

### General

Test voltage relay winding/relay contact	2 kV AC (50 Hz, 1 min.)
Test voltage relay contact/relay contact	2 kV AC (50 Hz, 1 min.)
Operating mode	100% operating factor
Mechanical service life	5x 10 <sup>7</sup> cycles
Service life, electrical	see diagram
Mounting position	any
Assembly instructions	On relay base PR2

### Standards and Regulations

Standards/regulations	DIN EN 61810-1
	VDE 0435-201
	EN 50178
Pollution degree	2
Overvoltage category	II

### Environmental Product Compliance

China RoHS	Environmentally friendly use period: unlimited = EFUP-e
	No hazardous substances above threshold values

## Drawings

# Single relay - REL-IR/LDM- 24DC/4X21AU - 2834203

Diagram

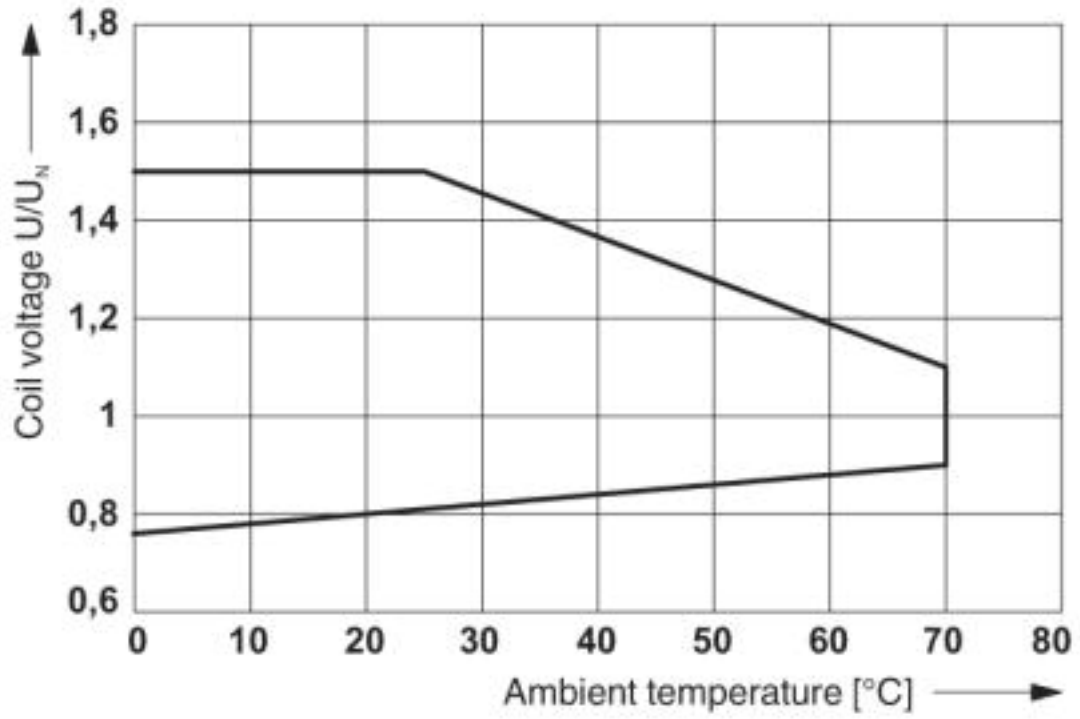

Operating voltage range

# Single relay - REL-IR/LDM- 24DC/4X21AU - 2834203

Diagram

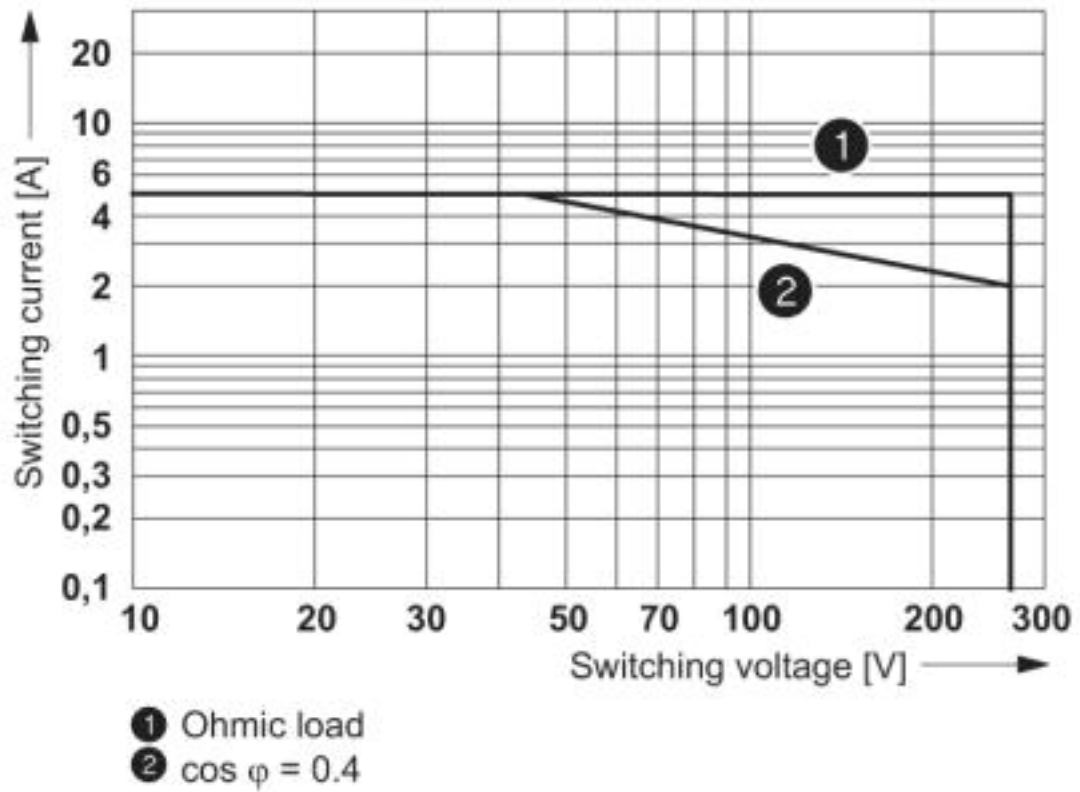

AC interrupting rating

# Single relay - REL-IR/LDM- 24DC/4X21AU - 2834203

Diagram

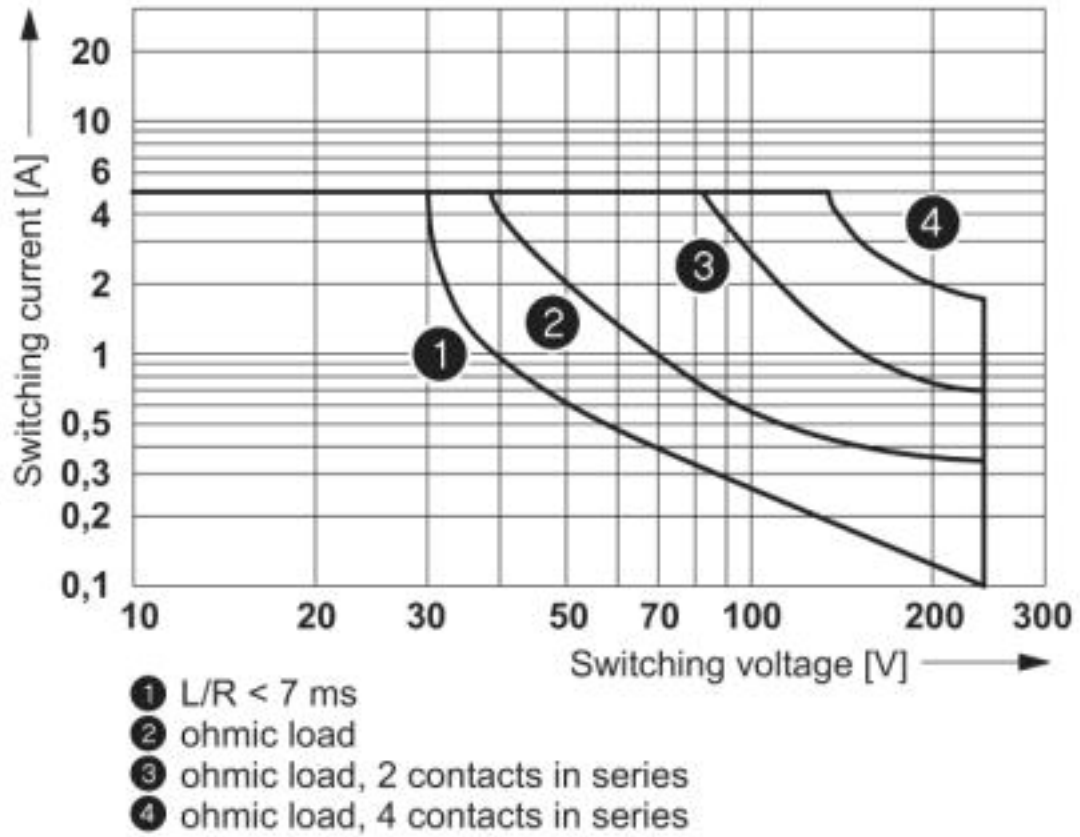

DC interrupting rating

# Single relay - REL-IR/LDM- 24DC/4X21AU - 2834203

Diagram

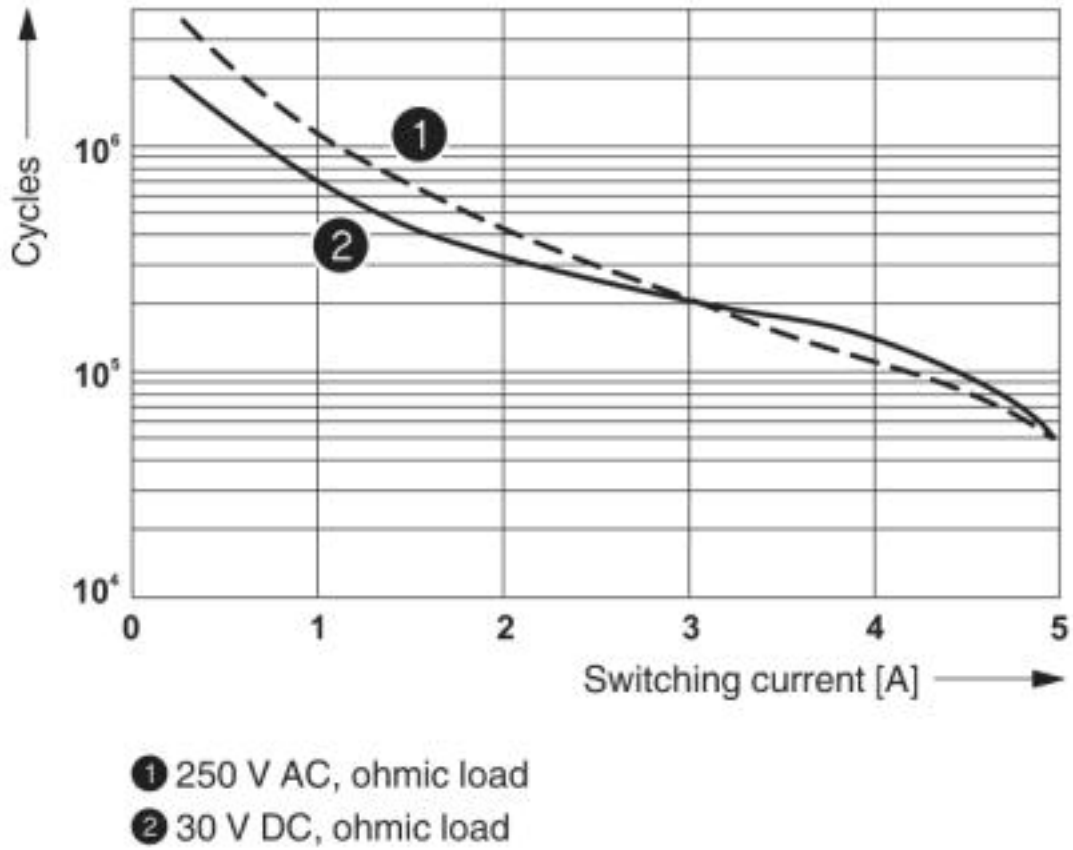

Electrical service life

# Single relay - REL-IR/LDM- 24DC/4X21AU - 2834203

Diagram

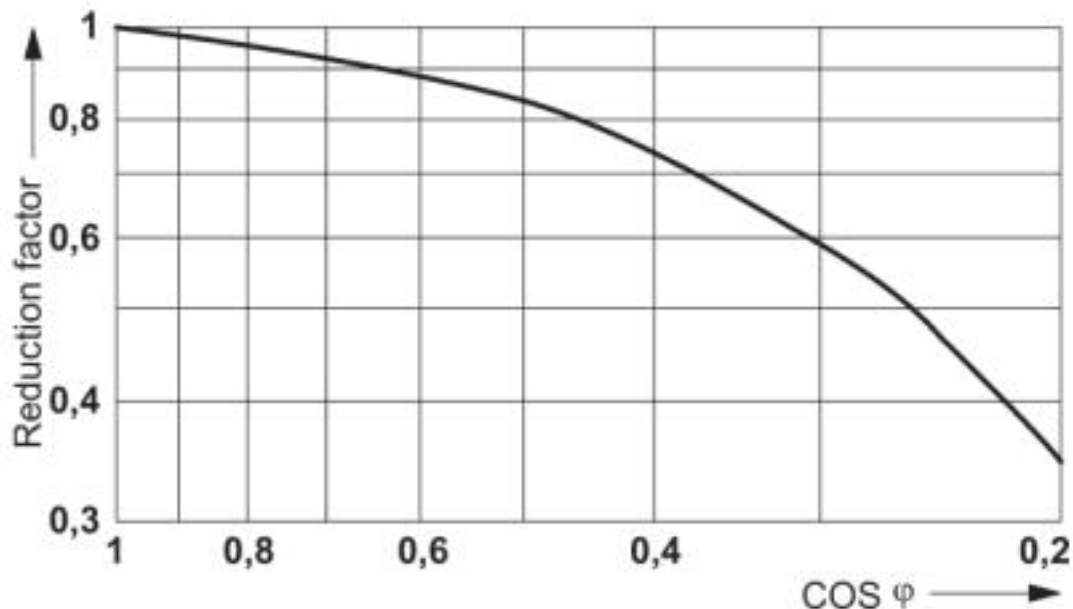

Service life reduction factor

Circuit diagram

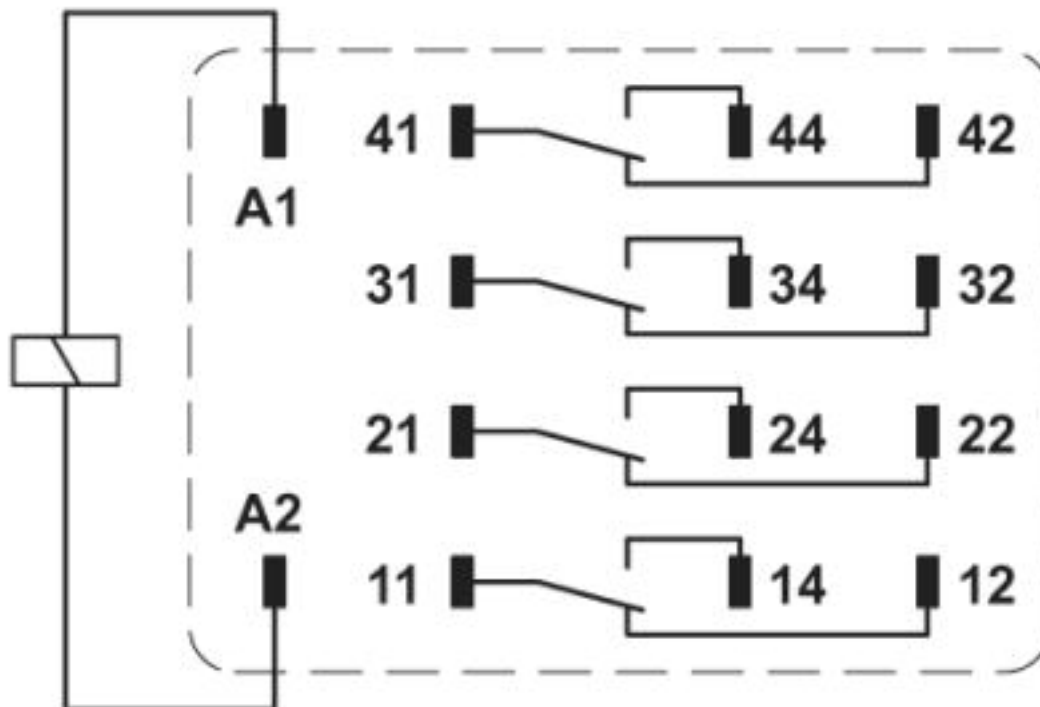

Shown without LED and damping diode.

# Single relay - REL-IR/LDM- 24DC/4X21AU - 2834203

## Classifications

### eCl@ss

eCl@ss 4.0	27371100
eCl@ss 4.1	27371100
eCl@ss 5.0	27371600
eCl@ss 5.1	27371600
eCl@ss 6.0	27371600
eCl@ss 7.0	27371601
eCl@ss 8.0	27371601
eCl@ss 9.0	27371601

### ETIM

ETIM 2.0	EC001437
ETIM 3.0	EC001437
ETIM 4.0	EC001437
ETIM 5.0	EC001437
ETIM 6.0	EC001437
ETIM 7.0	EC001437

### UNSPSC

UNSPSC 6.01	30211916
UNSPSC 7.0901	39121515
UNSPSC 11	39121515
UNSPSC 12.01	39121515
UNSPSC 13.2	39122334

## Approvals

### Approvals

#### Approvals

UL Listed / VDE Gutachten mit Fertigungsüberwachung / cUL Listed / EAC / EAC / cULus Listed

#### Ex Approvals

### Approval details

UL Listed		<a href="http://database.ul.com/cgi-bin/XYVV/template/LISEXT/1FRAME/index.htm">http://database.ul.com/cgi-bin/XYVV/template/LISEXT/1FRAME/index.htm</a>	FILE E 172140
-----------	---	---	---------------



# Single relay - REL-IR/LDM- 24DC/4X21AU - 2834203

## Approvals

VDE Gutachten mit Fertigungsüberwachung		<a href="http://www2.vde.com/de/Institut/Online-Service/VDE-gepruefteProdukte/Seiten/Online-Suche.aspx">http://www2.vde.com/de/Institut/Online-Service/VDE-gepruefteProdukte/Seiten/Online-Suche.aspx</a>	40026798
---	--	---	----------

cUL Listed		<a href="http://database.ul.com/cgi-bin/XYV/template/LISEXT/1FRAME/index.htm">http://database.ul.com/cgi-bin/XYV/template/LISEXT/1FRAME/index.htm</a>	FILE E 172140
------------	--	---	---------------

EAC			TR_TS_D_00573_c
-----	--	--	-----------------

EAC			TR_TS_S_00010_c
-----	--	--	-----------------

cULus Listed			
--------------	--	--	--

## Accessories

### Additional products

Relay base - PR2-BSC2/4X21 - 2833563



Relay base PR2-B, for industrial relay REL-IR with 2 or 4 PDT, 2/2-level version, screw connections, connection facility for input/interference suppression modules, for mounting on NS 35/7.5

Relay base - PR2-BSC3/4X21 - 2833576



Relay base PR2-B, for industrial relay REL-IR with 2 or 4 PDT, 1/3-level version, screw connections, connection facility for input/interference suppression modules, for mounting on NS 35/7.5

## Single relay - REL-IR/LDM- 24DC/4X21AU - 2834203

### Accessories

Relay base - PR2-BSP3/4X21 - 2833589



Relay base PR2-B, for industrial relay REL-IR with 2 or 4 PDT, 1/3-level version, spring-cage connections, connection facility for input/interference suppression modules, for mounting on NS 35/7.5

---

Phoenix Contact 2019 © - all rights reserved  
<http://www.phoenixcontact.com>