

Universal current transducer - MCR-SL-CUC-100-U - 2308108

Please be informed that the data shown in this PDF Document is generated from our Online Catalog. Please find the complete data in the user's documentation. Our General Terms of Use for Downloads are valid (<http://phoenixcontact.com/download>)

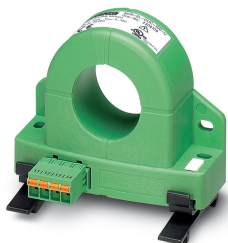

Universal current transducer, for measuring DC, AC, and distorted currents, 0 ... 100 A input current, 0 ... 10 V output

Your advantages

- ✓ Variable mounting on DIN rail and mounting plate
- ✓ Compact dimensions also enable distributed use
- ✓ Simple connection technology thanks to COMBICON plug-in connection terminal blocks
- ✓ Universal current measurement, no shunt required
- ✓ 3-way isolation



Key Commercial Data

Packing unit	1 pc
GTIN	
GTIN	4046356569736
Weight per Piece (excluding packing)	260.000 g
Weight per piece (including packing)	293.000 g
Custom tariff number	90303370
Country of origin	China

Technical data

Dimensions

Width	90 mm
Height	33.8 mm
Depth	85 mm

Ambient conditions

Ambient temperature (operation)	-40 °C ... 65 °C
Ambient temperature (storage/transport)	-40 °C ... 85 °C
Degree of protection	IP20

Universal current transducer - MCR-SL-CUC-100-U - 2308108

Technical data

Input data

Input current range	0 A ... 100 A
Overload capacity	6 x I _{IN}
Frequency measuring range	20 Hz ... 6000 Hz (0 Hz)
Connection method	Cable design: 32 mm diameter

Output data

Output name	Voltage output
Voltage output signal	0 V ... 10 V
Load/output load voltage output	≥ 10 kΩ

Switching output

Output name	No switching output
-------------	---------------------

Power supply

Nominal supply voltage	24 V DC
Supply voltage range	20 V DC ... 30 V DC
Max. current consumption	30 mA

Connection data

Connection method	Push-in connection
Stripping length	10 mm
Conductor cross section solid	0.25 mm ² ... 2.5 mm ²
Conductor cross section flexible	0.2 mm ² ... 2.5 mm ²
Conductor cross section AWG	24 ... 12

General

Maximum transmission error	<± 1 % (of final value)
Temperature coefficient, typical	0.02 %/K (0 °C ... 60 °C) 0.04 %/K (-40 °C ... 65 °C)
Linearity error	<± 1 % (From the range end value)
Step response (10-90%)	150 ms
Overvoltage category	III
Degree of pollution	2
Rated insulation voltage	300 V AC
Color	green
Housing material	Franyl B63 V0 GV30

Conformance/approvals

Designation	CE
Designation	UL, USA/Canada
Identification	UL/C-UL Listed UL 508

Environmental Product Compliance

China RoHS	Environmentally Friendly Use Period = 25;
------------	---

Universal current transducer - MCR-SL-CUC-100-U - 2308108

Technical data

Environmental Product Compliance

	For details about hazardous substances go to tab "Downloads", Category "Manufacturer's declaration"
--	---

Drawings

Dimensional drawing

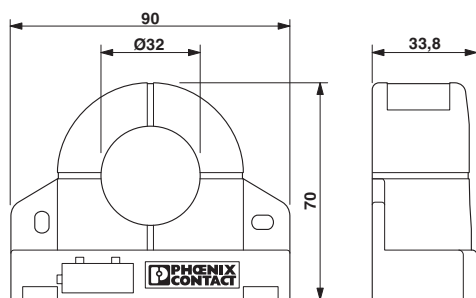

Circuit diagram

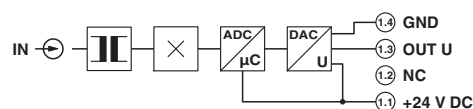

Schematic diagram

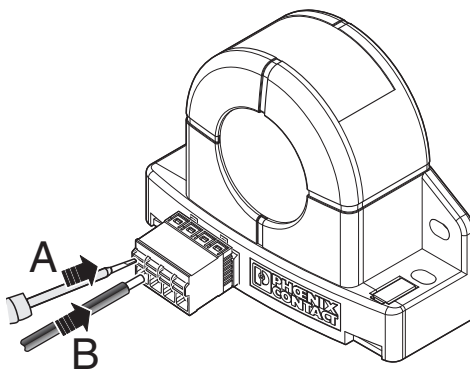

Classifications

eCl@ss

eCl@ss 10.0.1	27210123
eCl@ss 11.0	27210123
eCl@ss 4.0	27210900
eCl@ss 4.1	27210900
eCl@ss 5.0	27210900
eCl@ss 5.1	27210900
eCl@ss 6.0	27210100

Universal current transducer - MCR-SL-CUC-100-U - 2308108

Classifications

eCl@ss

eCl@ss 7.0	27210123
eCl@ss 9.0	27210123

ETIM

ETIM 3.0	EC002475
ETIM 4.0	EC002475
ETIM 6.0	EC002475
ETIM 7.0	EC002475

UNSPSC

UNSPSC 6.01	30211506
UNSPSC 7.0901	39121008
UNSPSC 11	39121008
UNSPSC 12.01	39121008
UNSPSC 13.2	39121032
UNSPSC 18.0	39121032
UNSPSC 19.0	39121032
UNSPSC 20.0	39121032
UNSPSC 21.0	39121032

Approvals

Approvals

Approvals

UL Listed / cUL Listed / EAC / cULus Listed

Ex Approvals

Approval details

UL Listed		http://database.ul.com/cgi-bin/XYV/template/LISEXT/1FRAME/index.htm	FILE E 123528
-----------	---	---	---------------

cUL Listed		http://database.ul.com/cgi-bin/XYV/template/LISEXT/1FRAME/index.htm	FILE E 123528
------------	---	---	---------------

Universal current transducer - MCR-SL-CUC-100-U - 2308108

Approvals

EAC		RU*DE.*08.B.01852-19
-----	---	----------------------

cULus Listed	
--------------	---